

S1.1

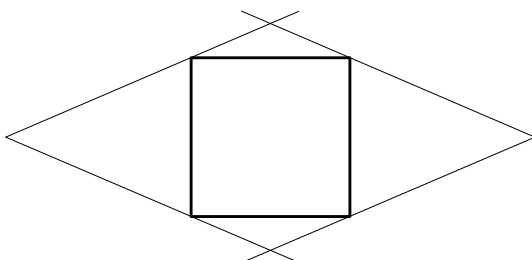

quadrat arbitrari i paral·leles

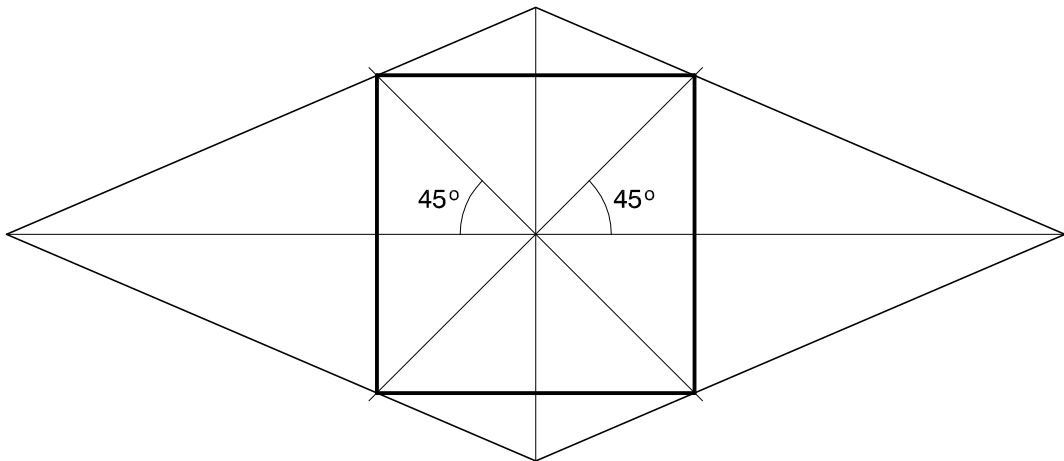
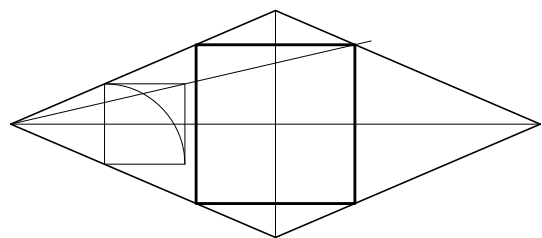

homotècia

opcions alternatives

S1.2A

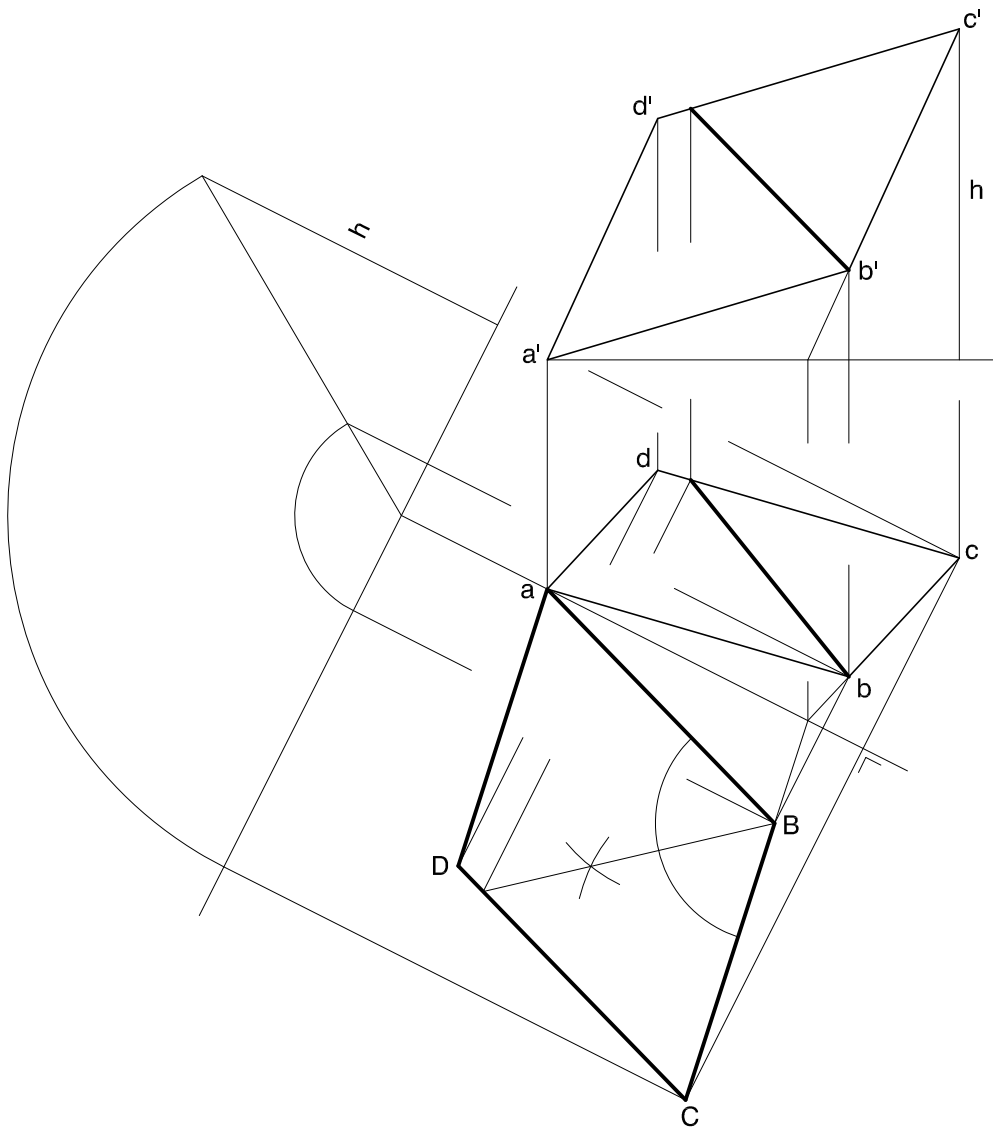

S1.3A

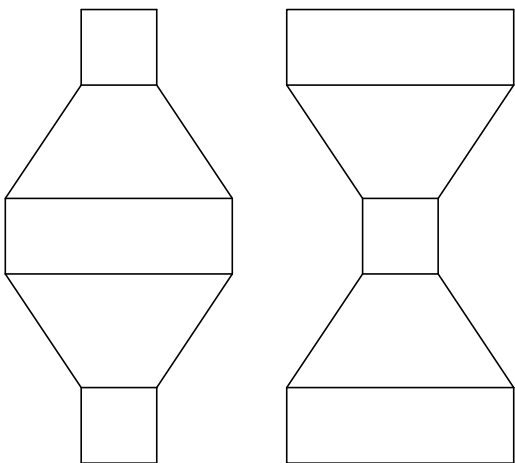

p'

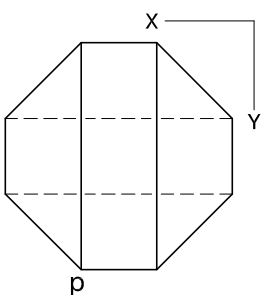

p

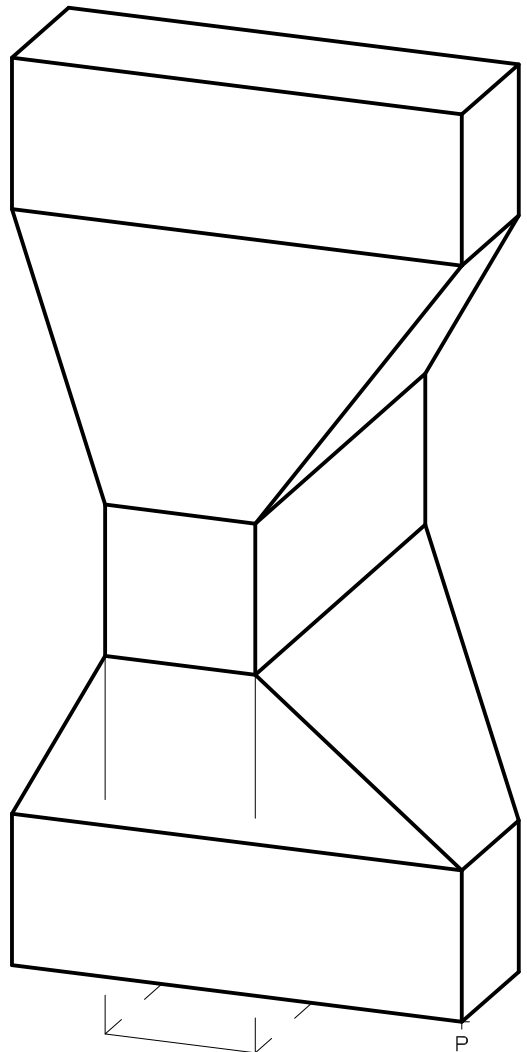
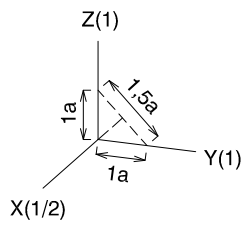

S1.3B

